

SL人形 (おきあがりこぼし)

Ver 1.1 2020 10 By M.M

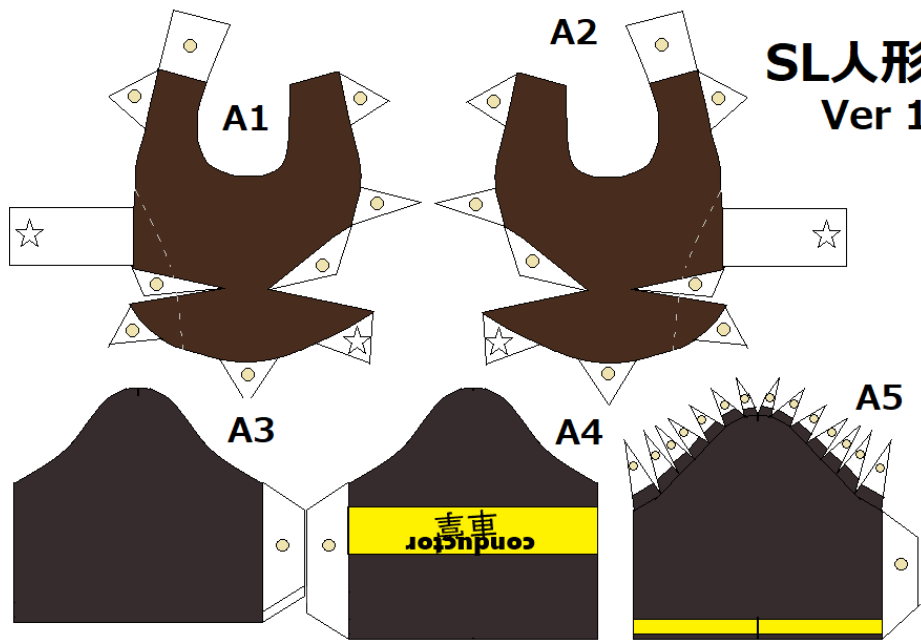

Not for sale 売り物ではありません



車掌さんのつもり
昔にあった銀河鉄道999を
思い出して作ってみた。
腕は好きな角度にして
みてください。
メッセージカードは
自分で作ってみては
どうでしょう・・・。

Conductor who
works at the
railroad train
of Japan.
Do you know
the anime called
to "Ginga
Tetudo 999"?



A15

準備するもの
はさみ
カッター
カッターマット
木工ボンド 速乾
爪楊枝
ボールペン
インクのない
(折り線用)
色鉛筆
端を着色
丸める補助
おもり
(ナットとか)

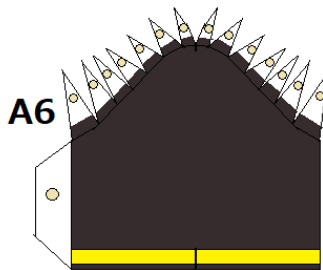

A6

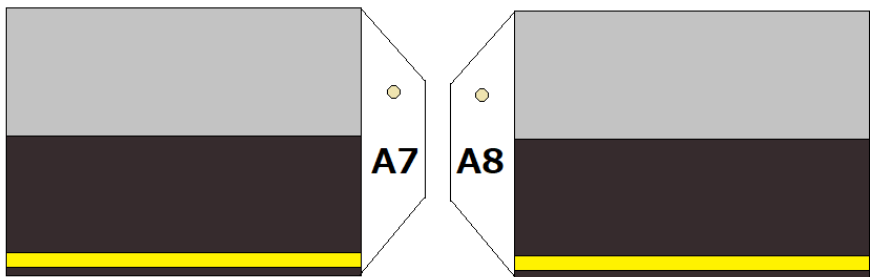

A7

A8

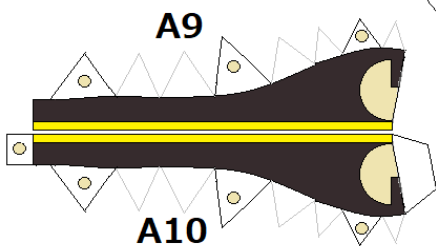

A9

A10



A11

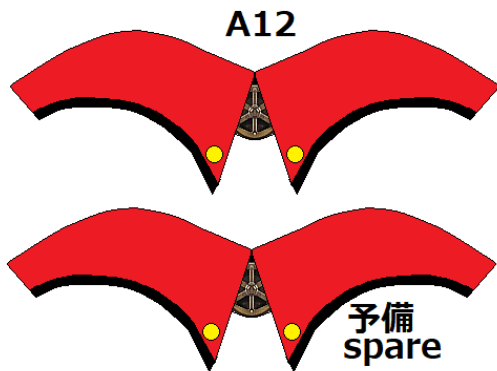

A12

予備
spare

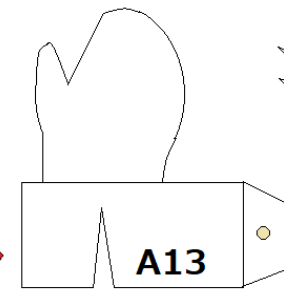

A13

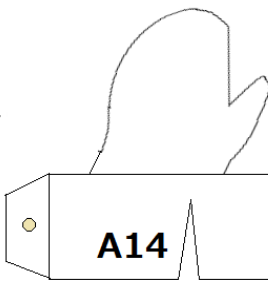

A14

A16
赤い線にそって
カット

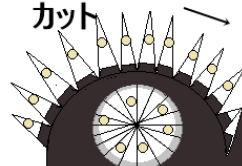

切り取る前に
カッターなどで
切っておく

予備
spare

おいでませ山口桜NAV I 提供



★カッターは部品を切り取る前に使う

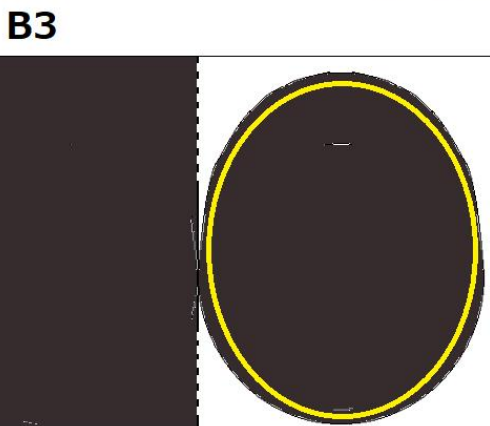
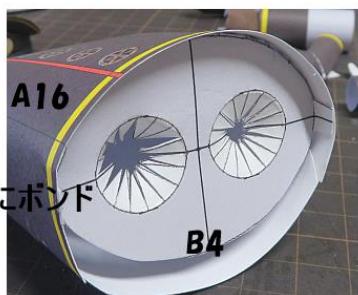
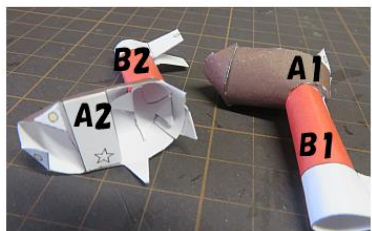
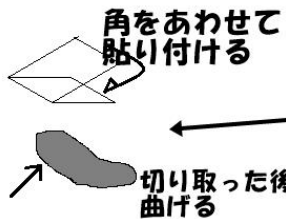
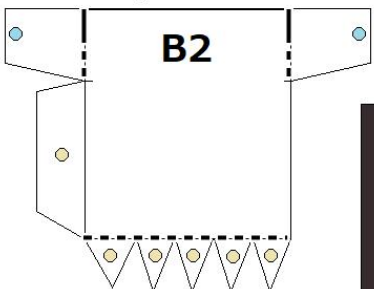
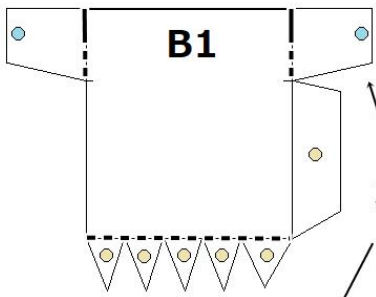

SL人形 (おきあがりこぼし)

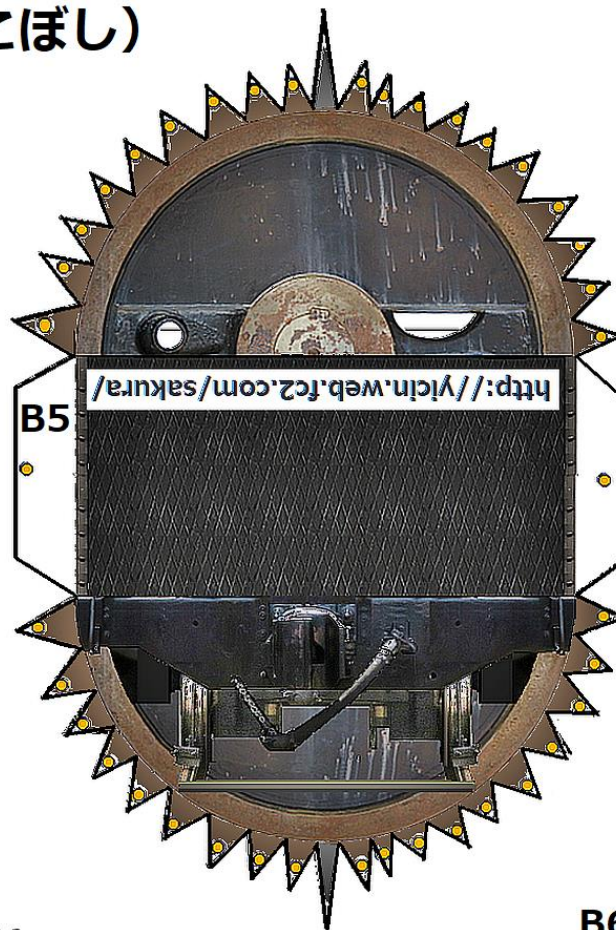
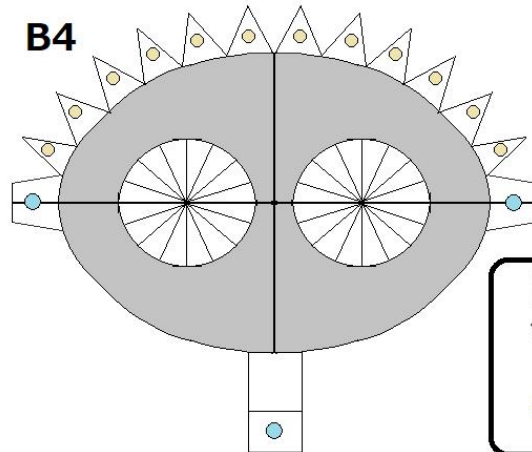
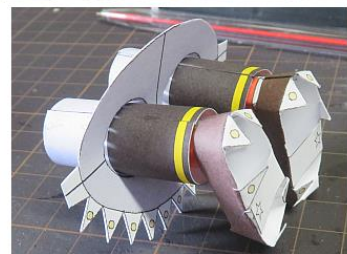
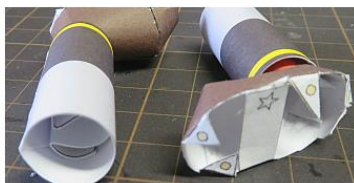

おもりが
必要です
Weight is necessary

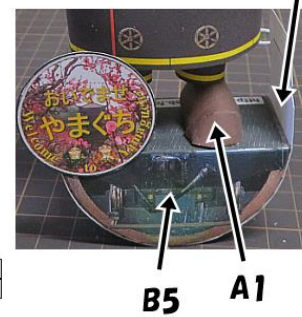
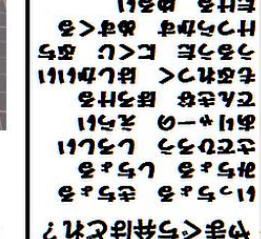
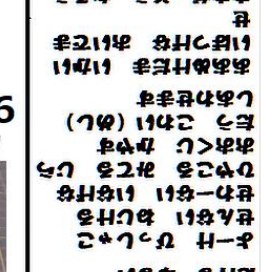
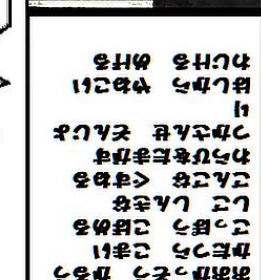

日々好日
今日もとっても
いい日!
観光ボランティア
おいでませ山口楼NAVI