

Not for sale
売り物ではない



a1



option



option

option

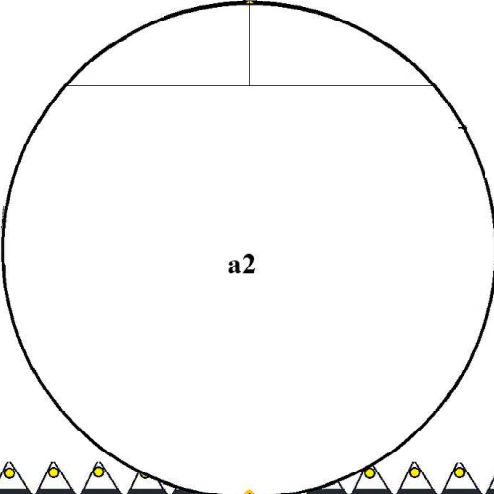

a2

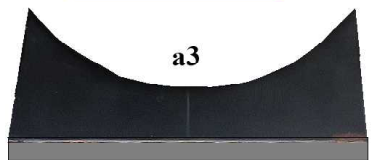
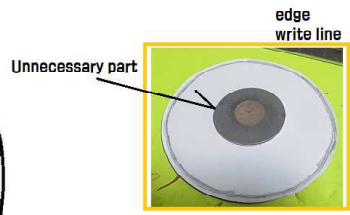

a3



option

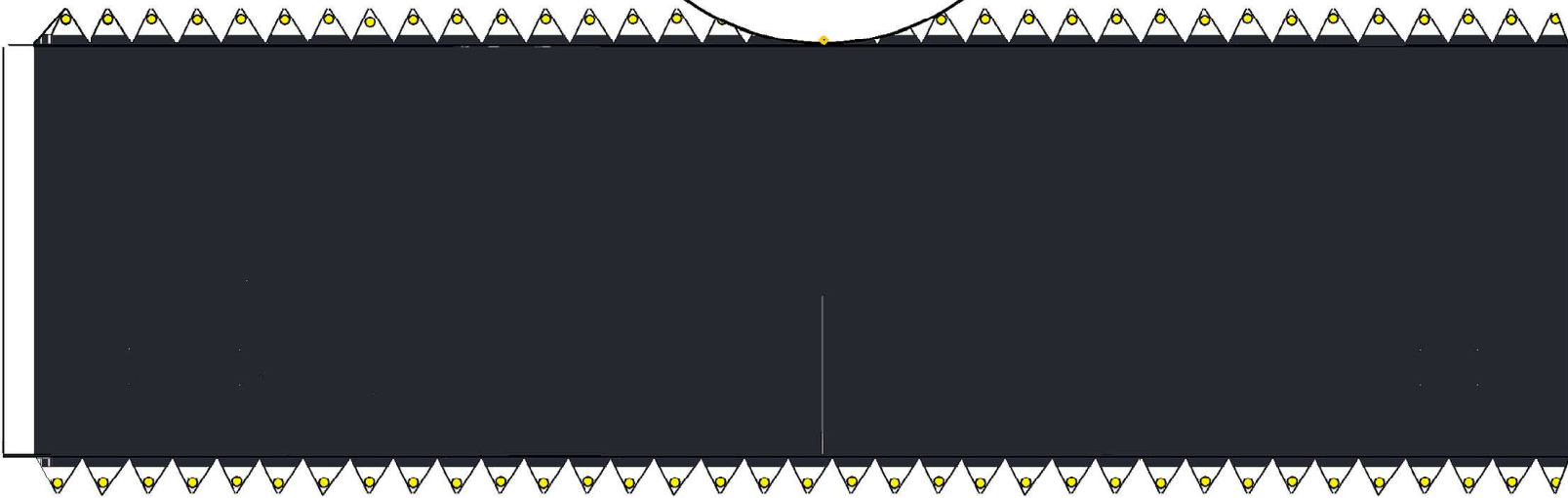

a9

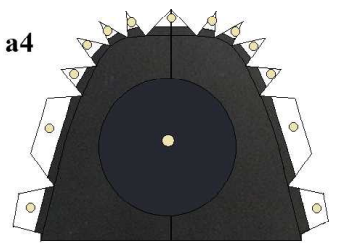

a4

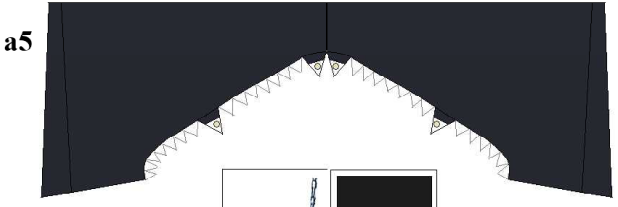

a5

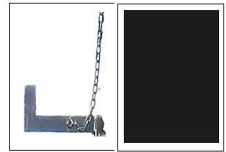

a6

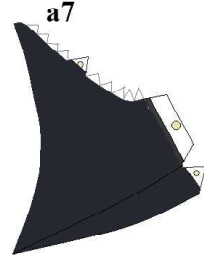

a7

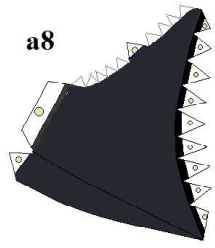

a8

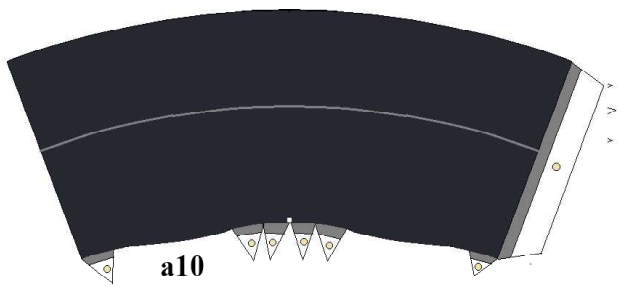

a10

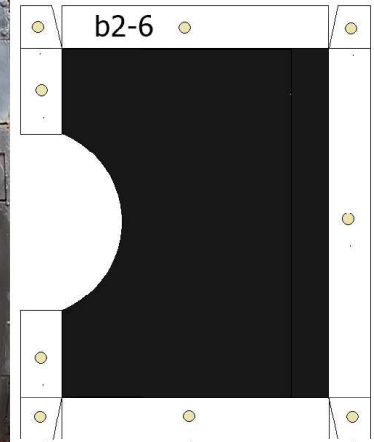
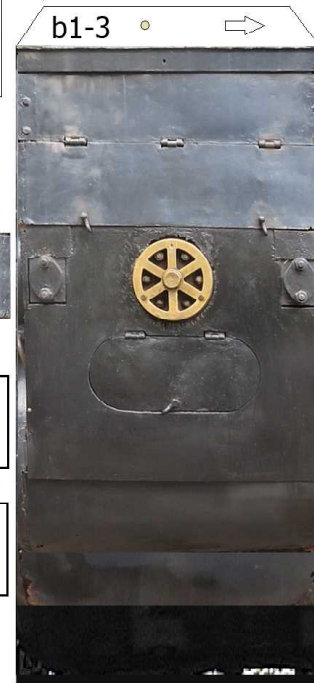
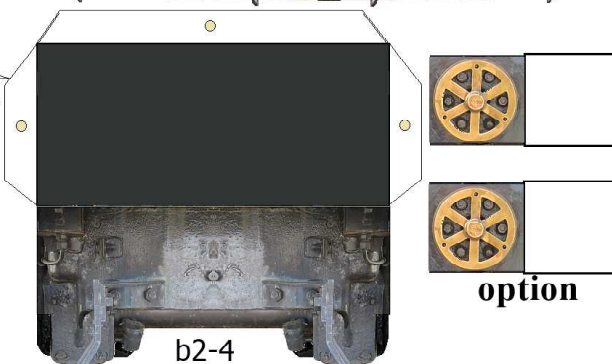
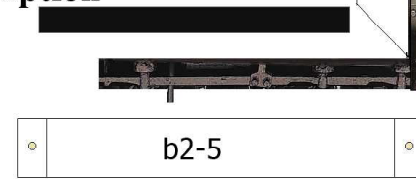
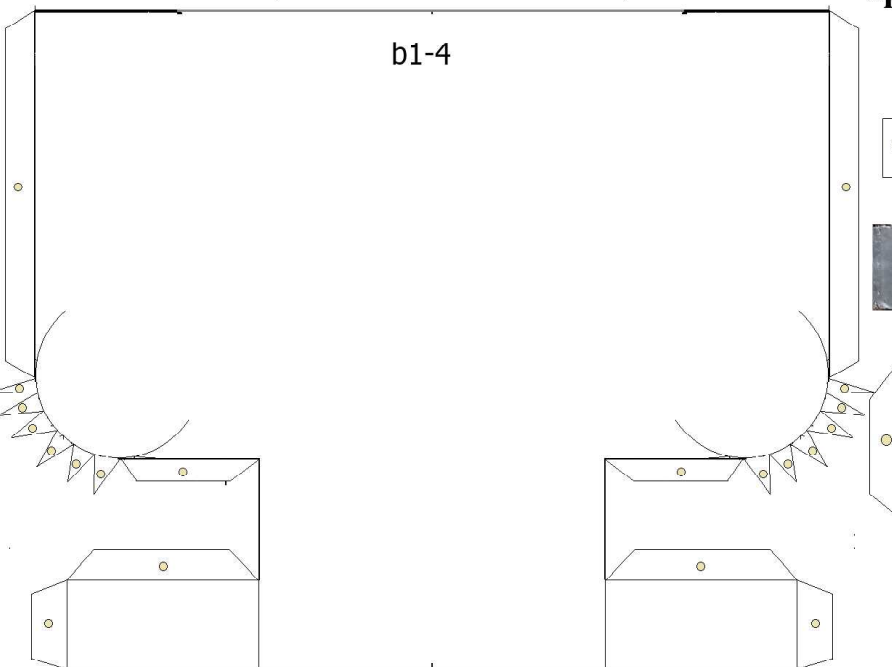
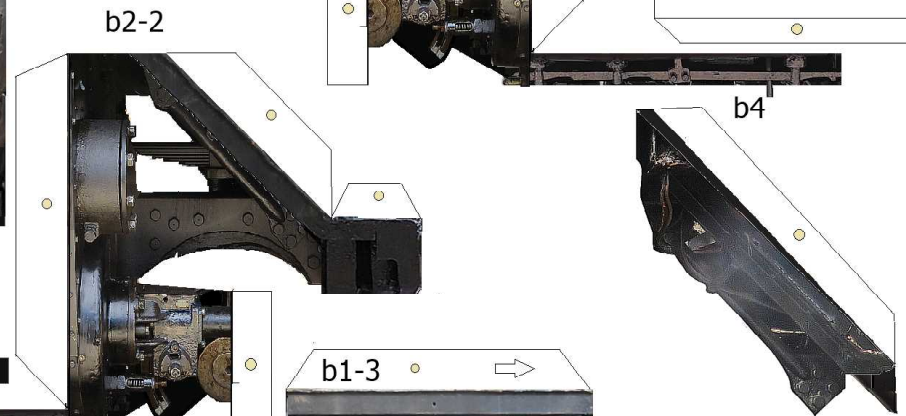
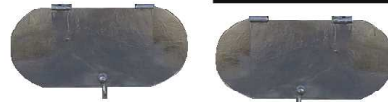
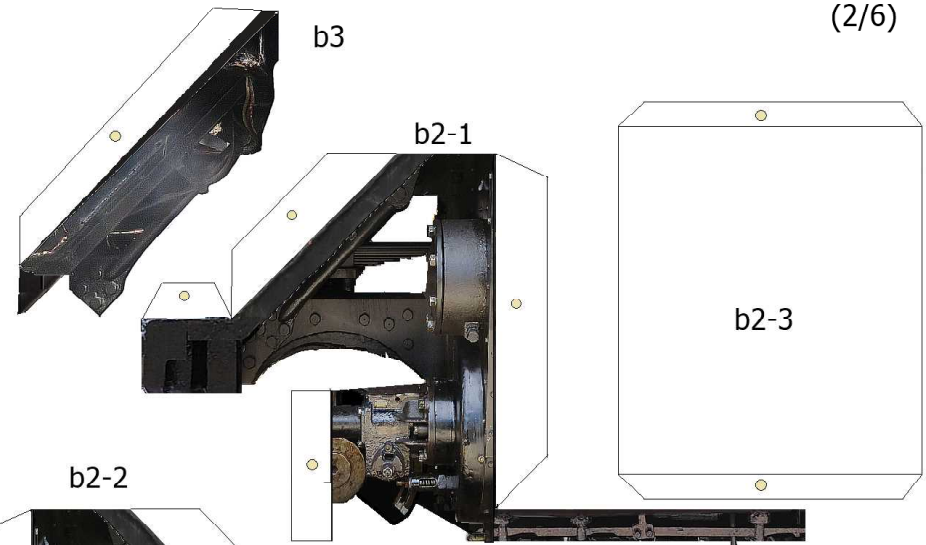
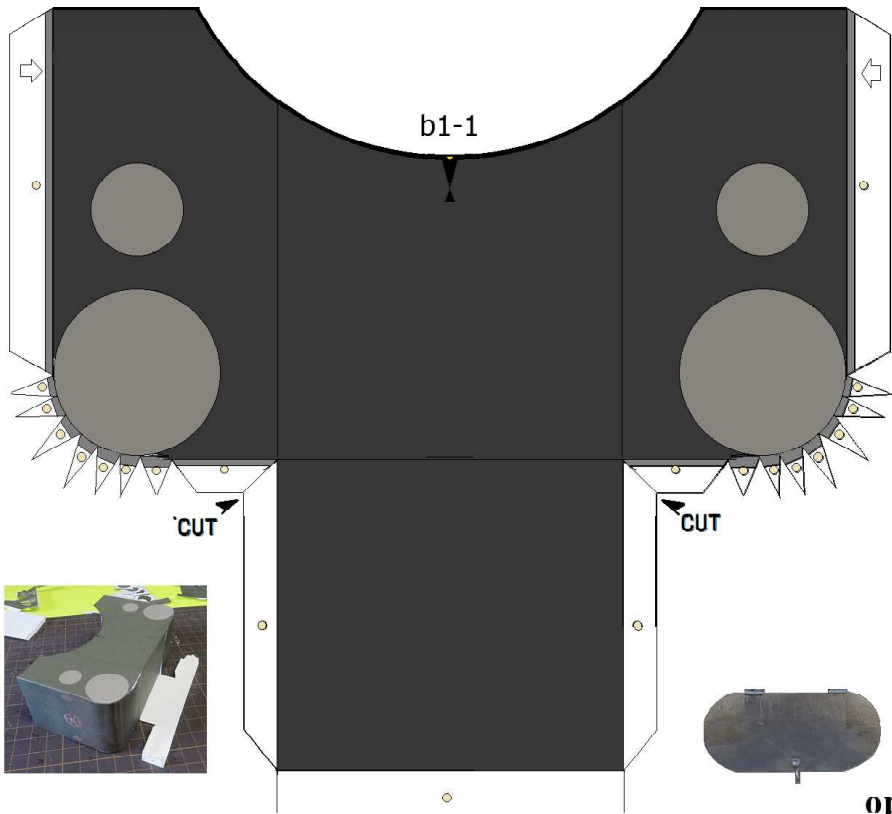

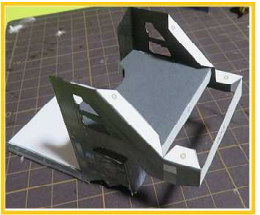
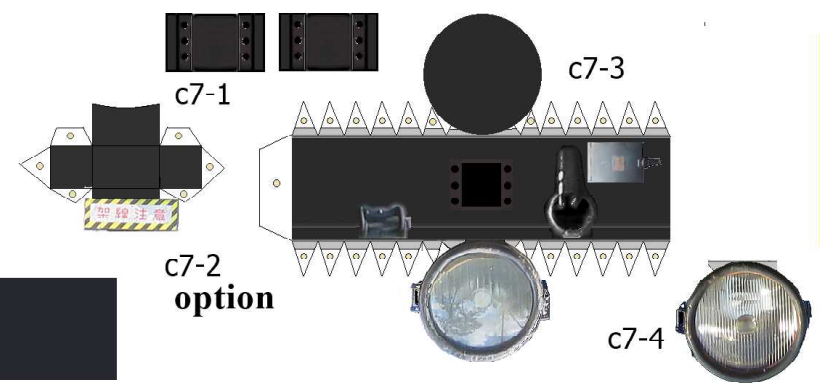
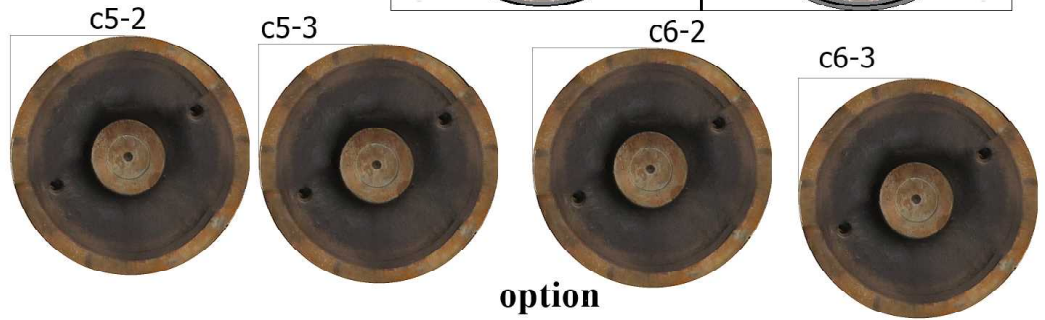
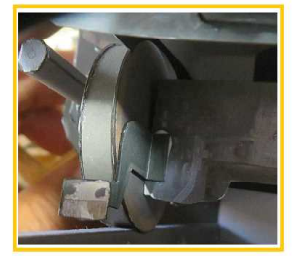
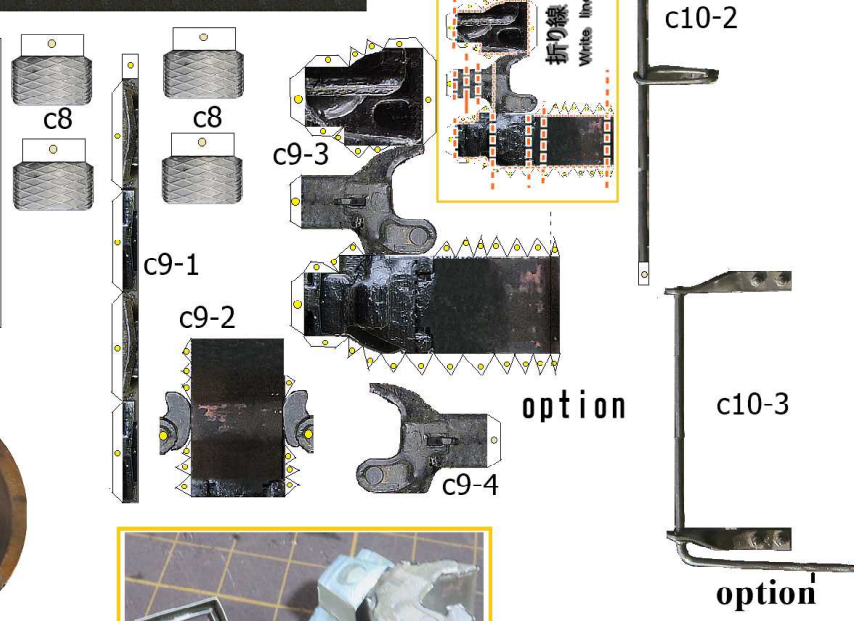
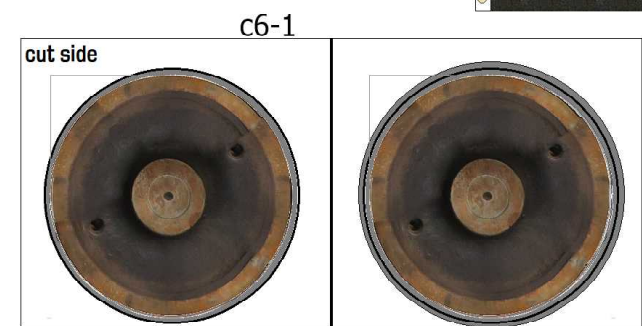
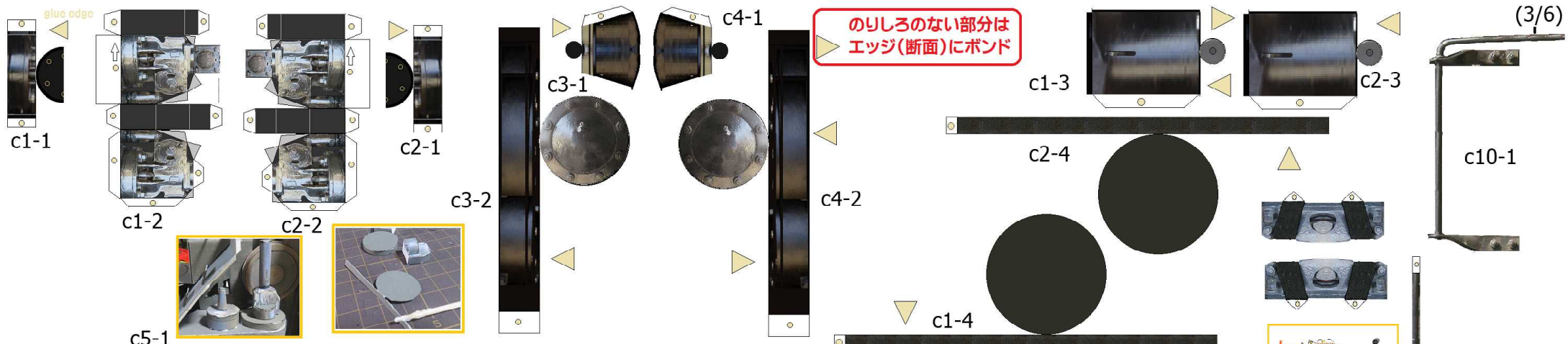

ア-14-3576・147654-11-V



d1-1

提供：観光ボランティア「おいでませ山口桜NAVI

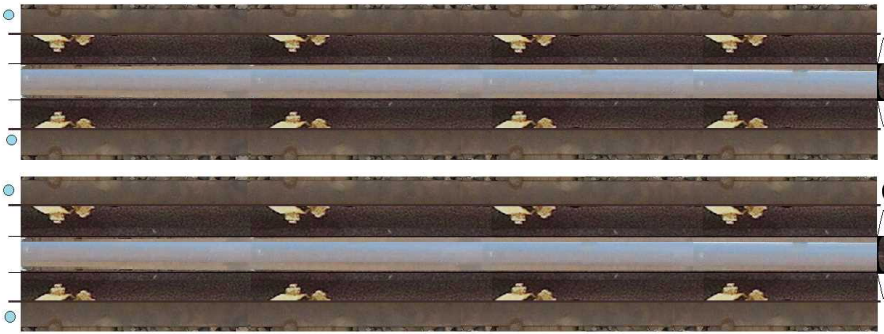

d1-3

d2-1

d1-4

option
d2-2

d2-3

d1-2

d5

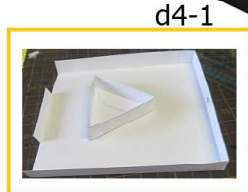

d4-1



d3-3



Ver. 2.6 M.Mihata

Not for sale
売り物ではない

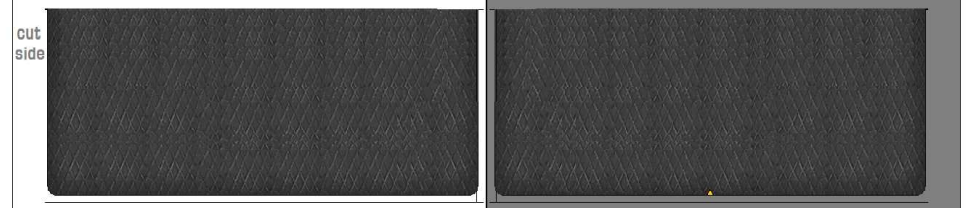

cut side

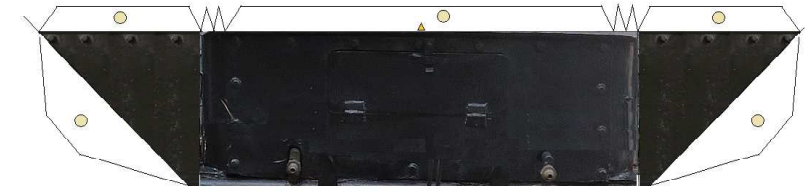

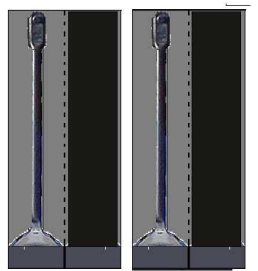
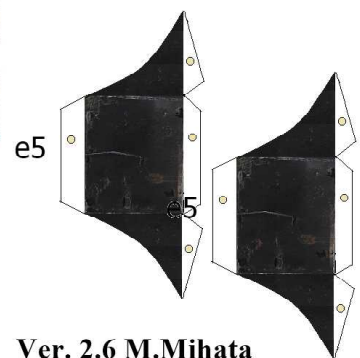
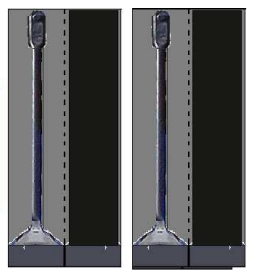
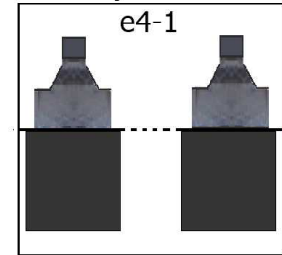
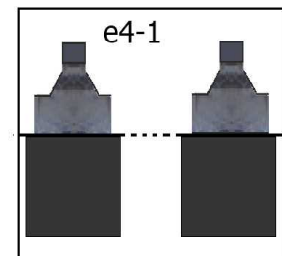
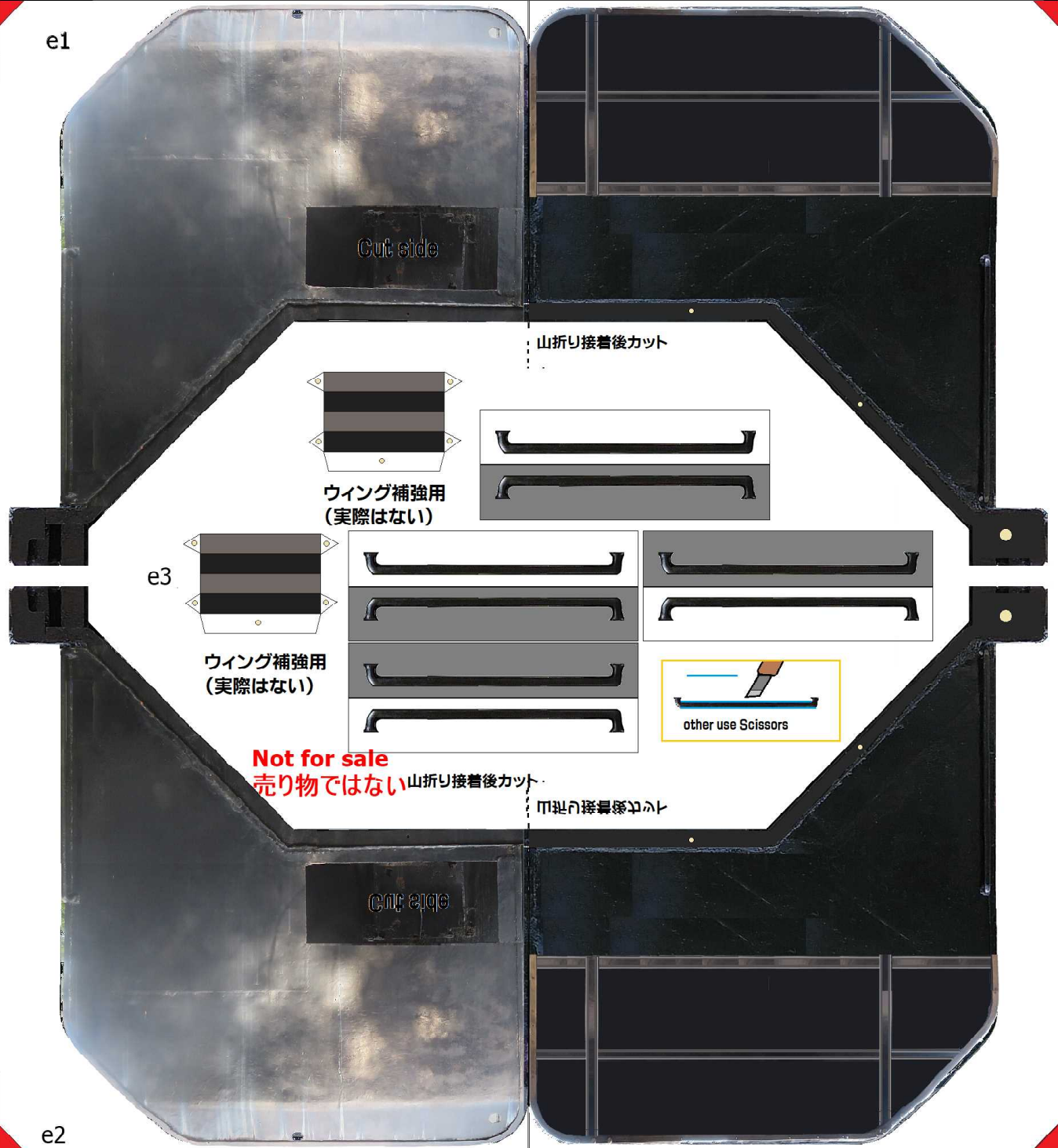

Ver. 2.6 M.Mihata

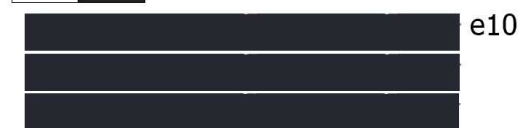
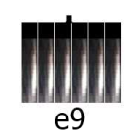
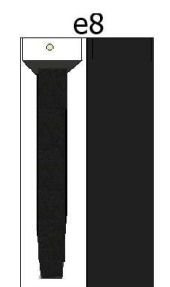

f1

f2

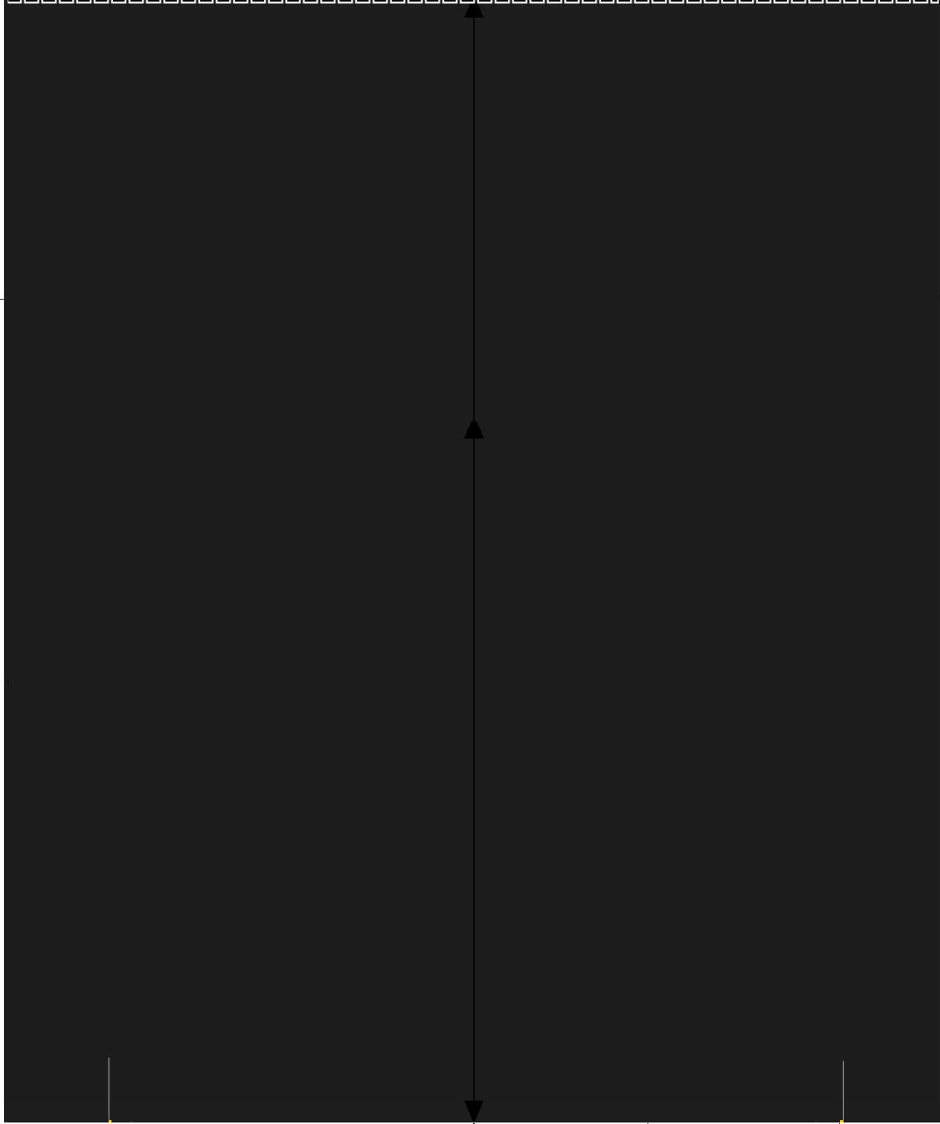

Message card



D5118号 経歴

製造年月日	昭和11年3月17日 汽車製造K.K.	機関車重量積	123 t
最大長	19.500mm	空	87.7t
最大巾	2.936mm	最高運転速度	85km/h
最大高	3.936mm	最高けん引力	1100 t

《D51型蒸気機関車の由来》

日本の代表機関車として、昭和11年に1号車が製作され以降近代標準機関車として、昭和20年まで製作され全国に1100両増備され、戦前・戦後の旅客・貨物輸送の代表車として、活躍したものであります。

なお、こう配は日本でD51が通った最高のこう配 $\frac{25}{1000}$ で、設置されています。

この機関車は、昭和45年10月から昭和47年12月1日まで厚狭機関区美祢線で、石灰石輸送の貨車用として活躍しました。

M.Mihata

パンフレット・手紙などを入れる箱

Not for sale
売り物ではない